

B-B (0,70 : 1)

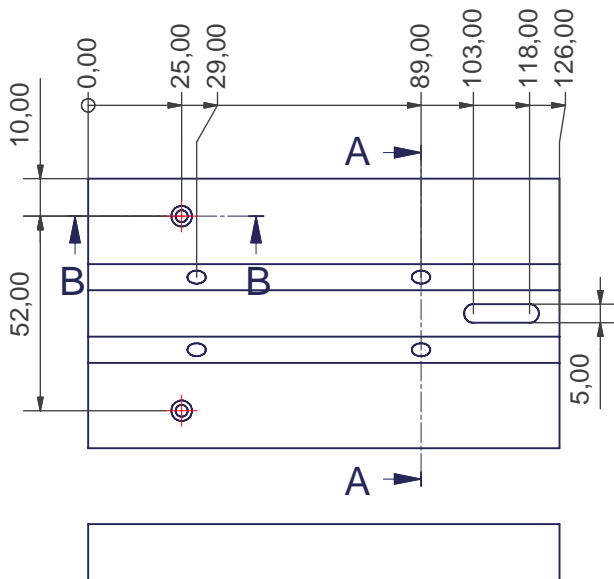

A-A (0,70 : 1)

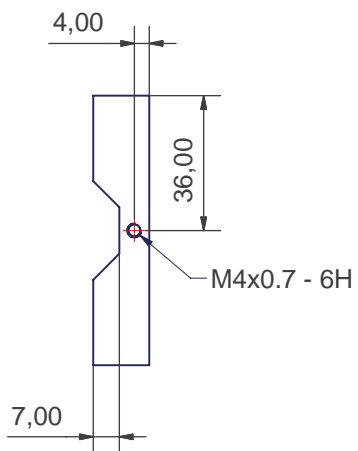
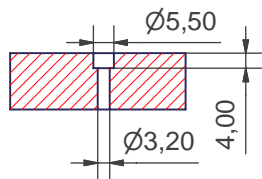
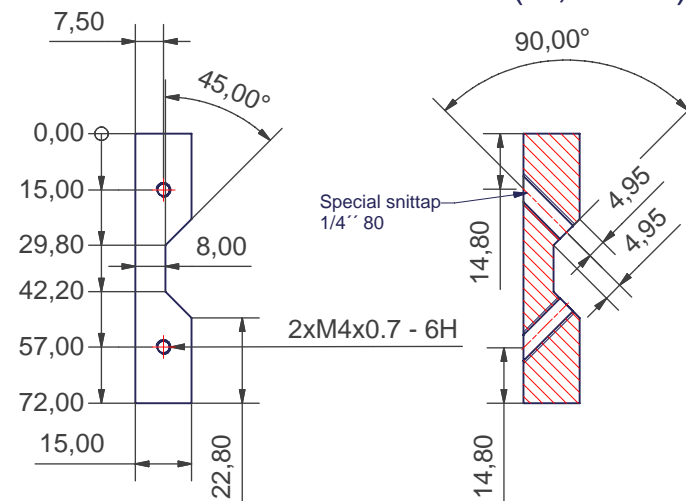

C-C (0,70 : 1)

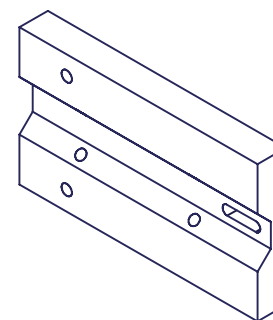
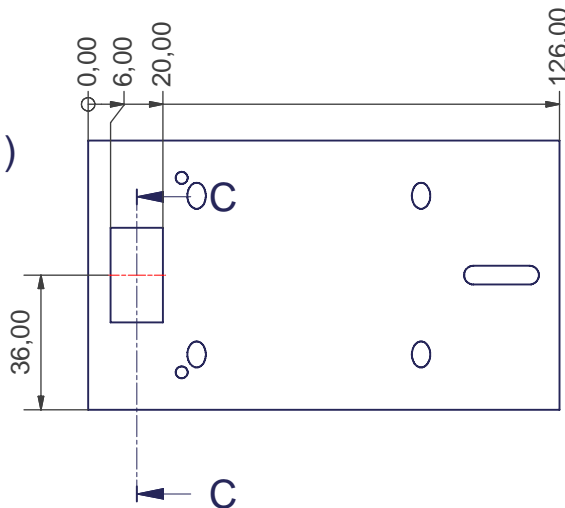
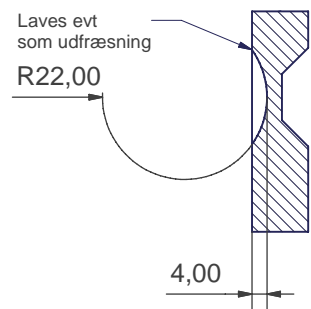

Institute of Physics and Astronomy Aarhus Universitet		IFA 		Mtr Aluminum	
				Designer John E. Andersen	
		Project Input V-Block			
		Creation date Last saved			
		15-10-2004 27aug04 - 8:48am		1-V-Block	
		Q:\Inventor DWG\Soren Frandsen\FIES\Input V-block\1-V-Block.ipt		Rev no. A3	
Rev	Changes	Date	Name		